



Duckworth & Kent

Ophthalmic Titanium Surgical Instruments

Packard - Rosen LRI Set

Titanium Instruments

4-621

Packard - Rosen LRI Diamond Knife

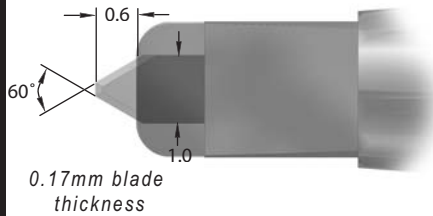

- Blade preset at 600 micron setting / extension
- Footplate designed to fit inside degree marker
- Distance from footplate to centre of diamond blade is 500 microns (0.5mm)
- Retractable long handle
- Length 118.0mm

Trifacet blade with single footplate allows easier visibility of knife as it passes through corneal tissue; 600 micron preset setting.

Packard - Rosen LRI Degree Fixation Marker

9-706 $\varnothing 12.0\text{mm}$

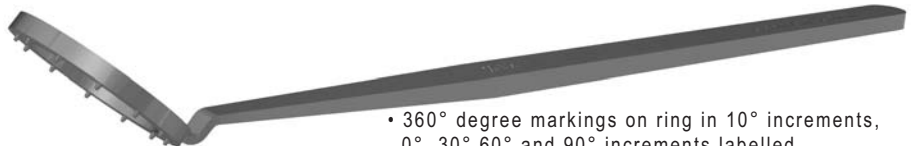

- 360° degree markings on ring in 10° increments, 0°, 30°, 60° and 90° increments labelled
- Range of sizes from 11.0mm to 14.0mm diameters
- 12 point fixation
- Flat handle, length 116.5mm

9-706-1 $\varnothing 13.0\text{mm}$

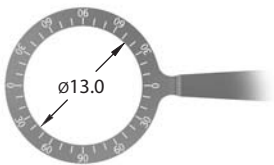

The single footplate profile of the diamond knife locates inside the degree fixation marker. By allowing the blade to follow the inner circumference of the degree fixation marker, a controlled incision can be created.

9-706-2 $\varnothing 14.0\text{mm}$

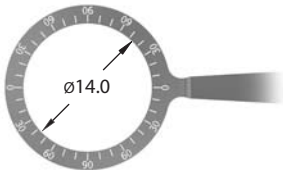

9-706-3 $\varnothing 11.0\text{mm}$

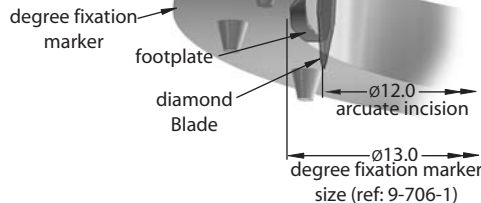
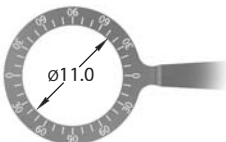

Diamond blade is offset 500 microns (0.5mm) from the inside of Degree Fixation Marker. With a $\varnothing 13.0\text{mm}$ LRI Degree Fixation Marker the Diamond Knife will create a $\varnothing 12.0\text{mm}$ arcuate incision.

Duckworth & Kent Ltd.

Terence House
7 Marquis Business Centre
Royston Road, Baldock
Herts SG7 6XL England

Tel: +44 (0)1462 893254 Fax: +44 (0)1462 896288
Web: www.duckworth-and-kent.com
Email: info@duckworth-and-kent.com

www.duckworth-and-kent.com





Wallace LRI Set

(Wallace Limbal Relaxing Kit for Reduction of Astigmatism)

Wallace Limbal Relaxing LRI "Kit" allows separate sterilizing capability in order that instruments may be used at the time when limbal relaxing incisions are clinically indicated.

4-620

Wallace LRI Diamond Knife

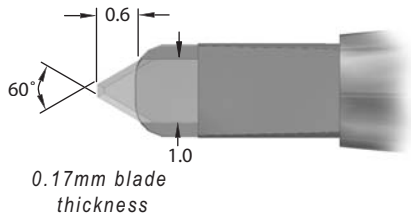

- 0.2mm front flat at tip
- 600 micron setting / extension
- Retractable long handle
- Length 120.0mm

Trifacet blade with single footplate allows easier visibility of knife as it passes through corneal tissue; 600 micron setting. Thin streamlined handle for finger twirling as blade follows arcuate pattern of the limbus.

9-705R

Wallace-Mendez Degree Gauge



- Measures 0° - 180° in 10° increments x 2
- Round handle, length 105.0mm

10° interval marks. Designed for surgeons familiar with use of a standard phoropter.

2-138D

DK Colibri Forceps

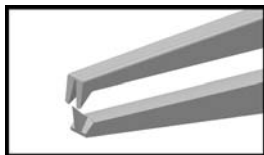

- 0.12mm, 1 x 2 teeth, tip length 2.5mm
- 6.0mm tying platforms
- Colibri style shafts
- Dolphin handle, length 94.0mm

Allows for marking intended incision sites as well as fixation of globe for LRI procedure.

Titanium Instruments

Duckworth & Kent Ltd.

Terence House
7 Marquis Business Centre
Royston Road, Baldock
Herts SG7 6XL England

Tel: +44 (0)1462 893254 Fax: +44 (0)1462 896288
Web: www.duckworth-and-kent.com
Email: info@duckworth-and-kent.com

www.duckworth-and-kent.com





Barrett LRI Set

Titanium Instruments

4-622

Barrett LRI Diamond Knife



0.17mm blade thickness



- Blade preset at 550 micron setting / extension
- 8 facet vertical cutting blade
- Retractable long handle
- Length 125mm

The diamond knife has a unique double sided footplate for lateral support on the diamond blade, with an opening behind the footplate to give good visibility.

Barrett Limbal Markers



view on top of marker

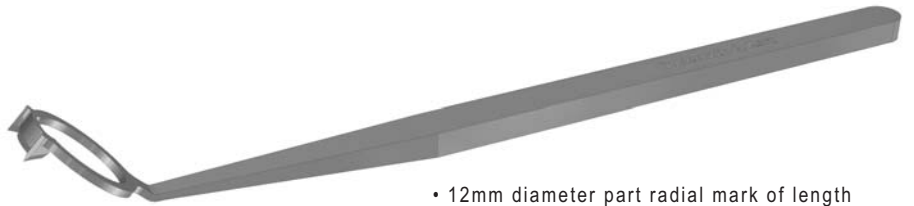

- 12mm diameter part radial mark of length 6.0mm (ref: 9-741-1) or 8.0mm (ref: 9-741-2)
- Two 2.0mm side marks
- Instruments uniquely coloured for identification Gold (ref: 9-741-1) or Blue (ref: 9-741-2)
- Length 114mm

9-741-1

6.0mm arc length on 12.0mm diameter

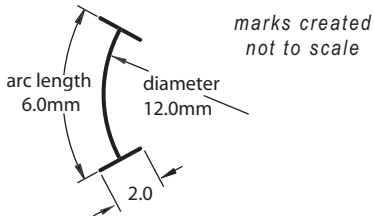

9-741-2

8.0mm arc length on 12.0mm diameter

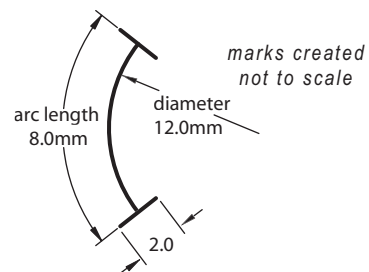

Duckworth & Kent Ltd.

Terence House
7 Marquis Business Centre
Royston Road, Baldock
Herts SG7 6XL England

Tel: +44 (0)1462 893254 Fax: +44 (0)1462 896288
Web: www.duckworth-and-kent.com
Email: info@duckworth-and-kent.com

www.duckworth-and-kent.com





Duckworth & Kent

Ophthalmic Titanium Surgical Instruments

DK LRI Set

Titanium Instruments

5-835

DK Three Position Diamond Knife, 45° Double Edge

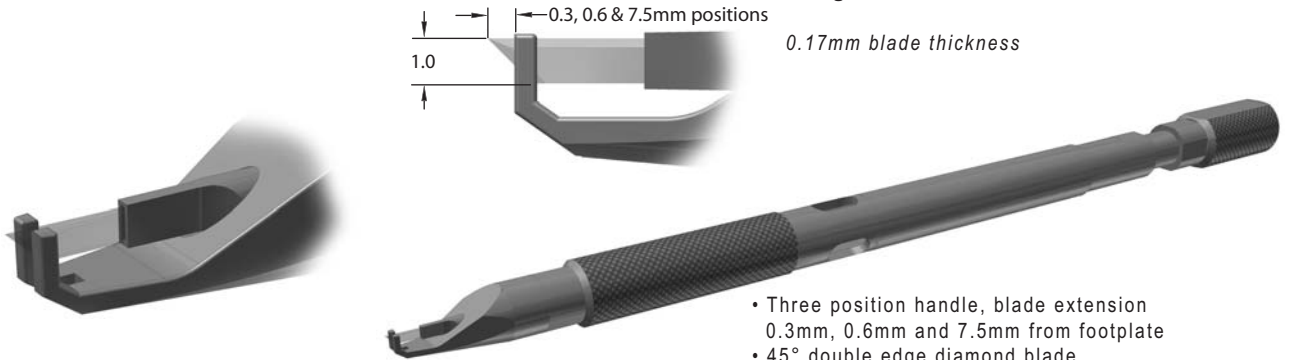

- Three position handle, blade extension 0.3mm, 0.6mm and 7.5mm from footplate
- 45° double edge diamond blade
- Length 128mm

9-700

DK Mendez Degree Gauge

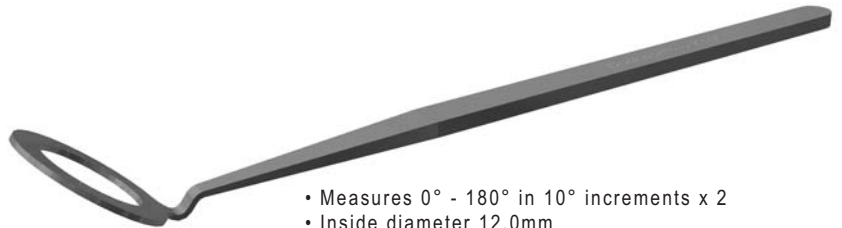
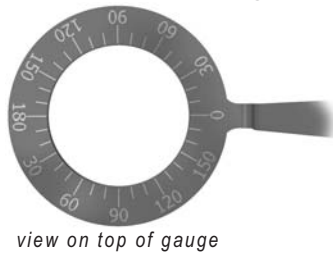

- Measures 0° - 180° in 10° increments x 2
- Inside diameter 12.0mm
- Flat handle, length 118.0mm

Round handle version available, specify 9-700R

9-746

Gayton 360 Degree Marker

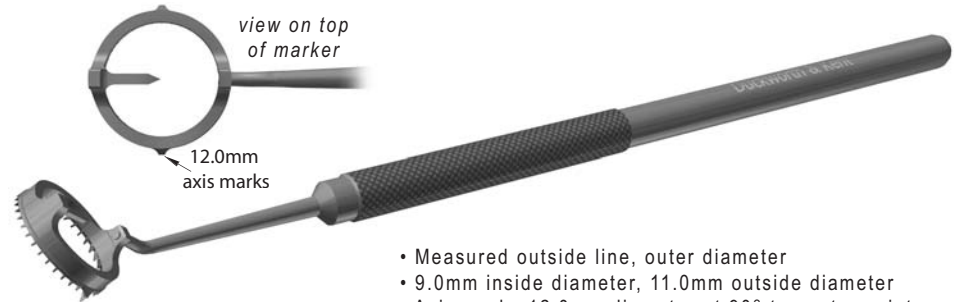
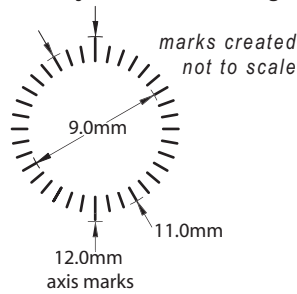

- Measured outside line, outer diameter
- 9.0mm inside diameter, 11.0mm outside diameter
- Axis marks 12.0mm diameter at 90° to center pointer
- Round handle, length 126.0mm
- Package insert certification

Designed to mark 10° intervals through 360° at 9.0mm to 11.0mm diameter. Instrument fits into the Mendez Degree Gauge (ref: 9-700 & 9-700R).

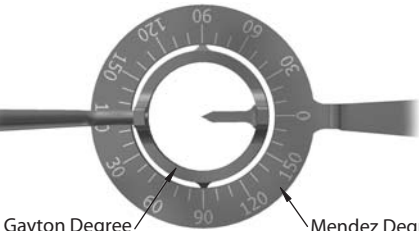

Gayton Degree Marker, 9-746

Mendez Degree Gauge, 9-700

Duckworth & Kent Ltd.

Terence House
7 Marquis Business Centre
Royston Road, Baldock
Herts SG7 6XL England

Tel: +44 (0)1462 893254 Fax: +44 (0)1462 896288

Web: www.duckworth-and-kent.com

Email: info@duckworth-and-kent.com

www.duckworth-and-kent.com

